

① Front View
1" = 1'-0"

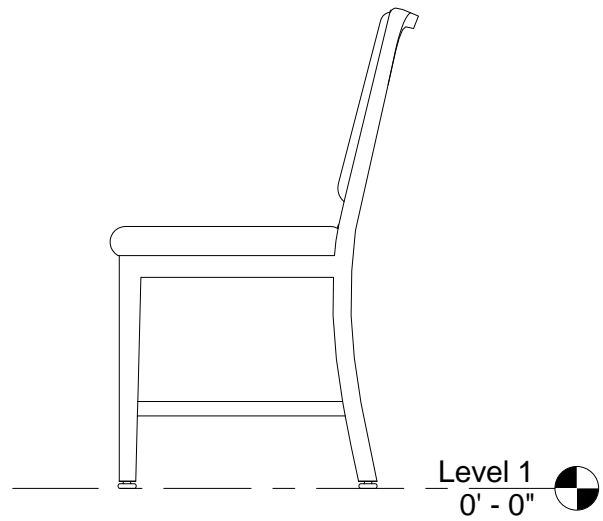

② Side View
1" = 1'-0"

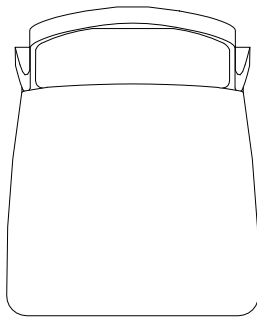

③ Plan View
1" = 1'-0"



④ 3D View

Autodesk® Revit®

www.autodesk.com/revit

Emeco
EMC Revit
Families

Navy® 1002

Project number	C130248
Date	131101
Drawn by	Contino
Checked by	Contino

A109

Scale 1" = 1'-0"