

1 Front View  
1" = 1'-0"

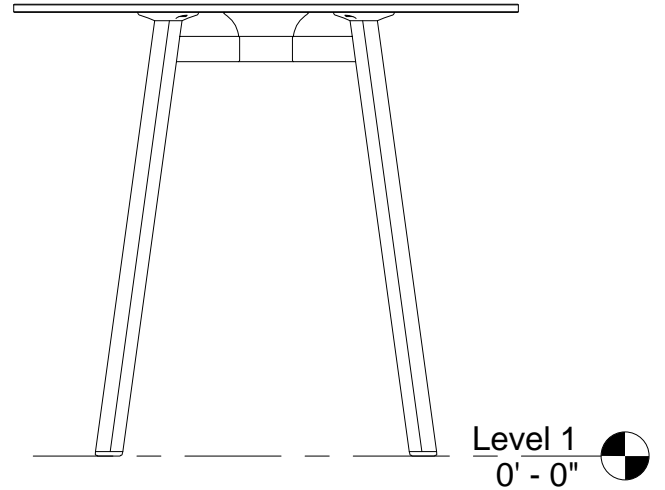

2 Side View  
1" = 1'-0"

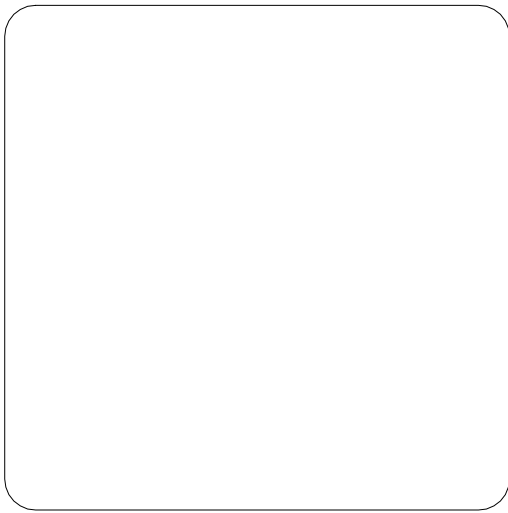

3 Plan View  
1" = 1'-0"



4 3D View



Emeco  
EMC Revit  
Families

SU TABLE - T32

Project number	CG160783
Date	160613
Drawn by	Contino
Checked by	Contino

A100

Scale 1" = 1'-0"